

# Data Sheet



Article number: 72018050022

Description: Gear Head SGN50B I=50  
Pinion input

## Measures

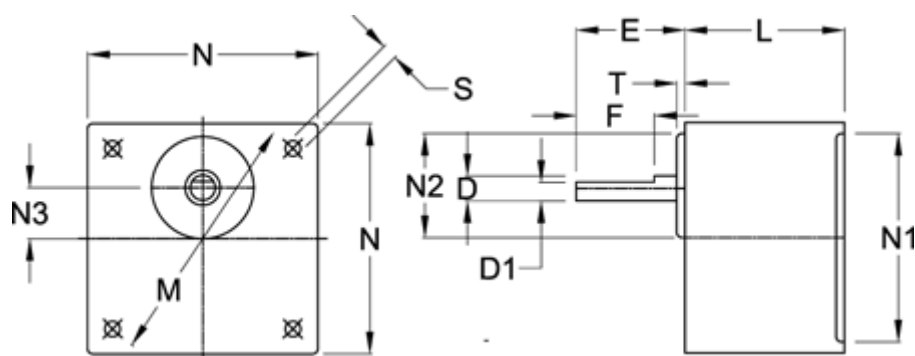

D = 10	N2 = 34
D1 = 7.5	N3 = 15
E = 35	S = 4x $\varnothing$ 5,5
F = 25	T = 5
L = 40	
M = 94	
N = 80	
N1 = 73	